



## Public Key Encryption from trapdoor permutations

Public key encryption:  
definitions and security

# Public key encryption

Bob: generates  $(PK, SK)$  and gives  $PK$  to Alice

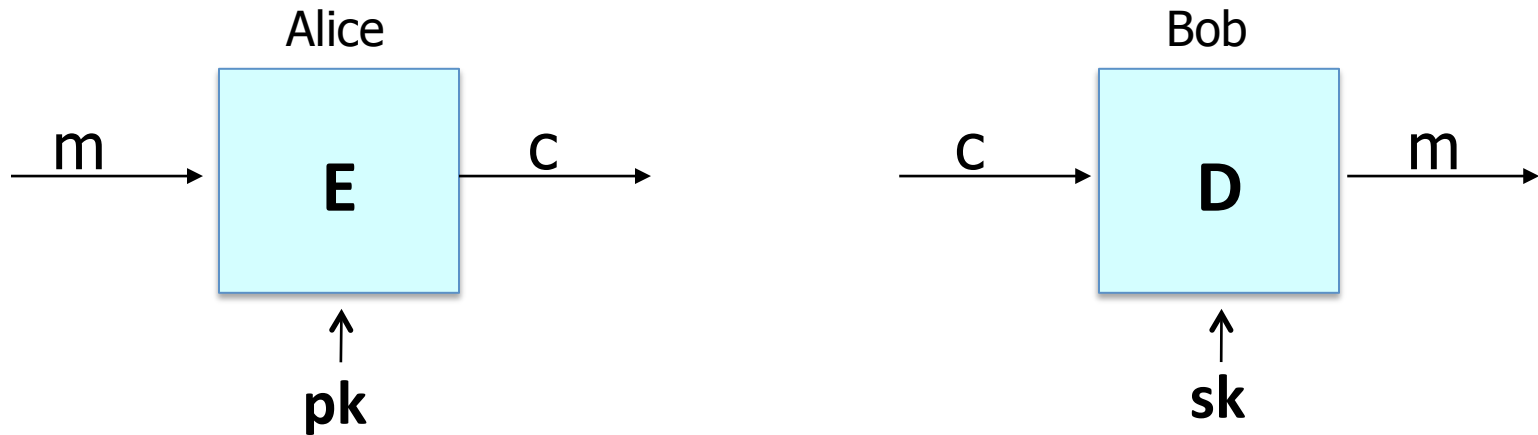

# Applications

**Session setup** (for now, only eavesdropping security)

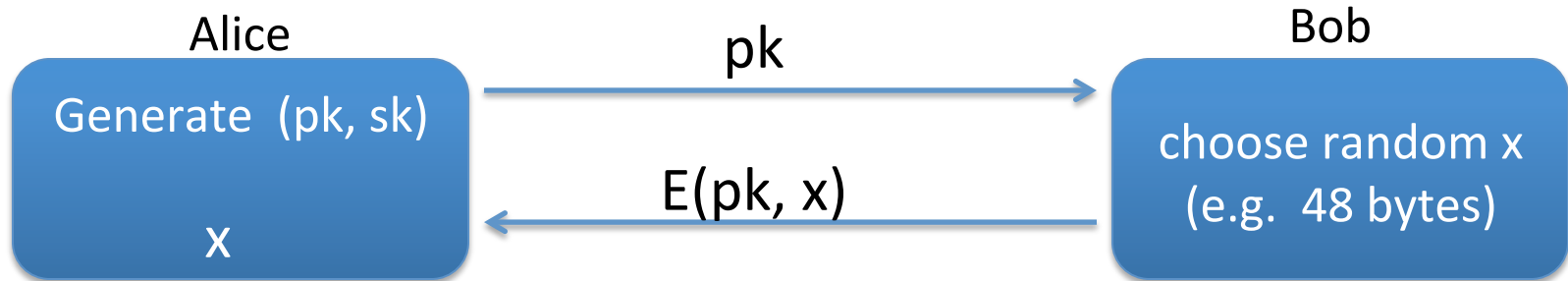

**Non-interactive applications:** (e.g. Email)

- Bob sends email to Alice encrypted using  $pk_{\text{alice}}$
- Note: Bob needs  $pk_{\text{alice}}$  (public key management)

# Public key encryption

**Def:** a public-key encryption system is a triple of algs.  $(G, E, D)$

- $G()$ : randomized alg. outputs a key pair  $(pk, sk)$
- $E(pk, m)$ : randomized alg. that takes  $m \in M$  and outputs  $c \in C$
- $D(sk, c)$ : det. alg. that takes  $c \in C$  and outputs  $m \in M$  or  $\perp$

Consistency:  $\forall (pk, sk)$  output by  $G$  :

$$\forall m \in M: D(sk, E(pk, m)) = m$$

# Security: eavesdropping

For  $b=0,1$  define experiments  $\text{EXP}(0)$  and  $\text{EXP}(1)$  as:

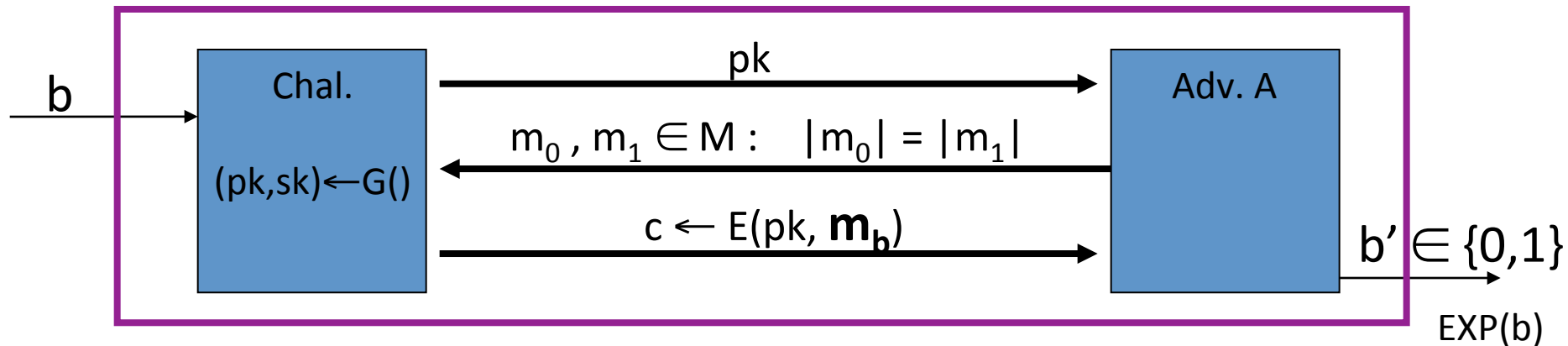

Def:  $E = (G, E, D)$  is sem. secure (a.k.a IND-CPA) if for all efficient  $A$ :

$$\text{Adv}_{SS} [A, E] = \left| \Pr[\text{EXP}(0)=1] - \Pr[\text{EXP}(1)=1] \right| < \text{negligible}$$

# Relation to symmetric cipher security

Recall: for symmetric ciphers we had two security notions:

- One-time security and many-time security (CPA)
- We showed that one-time security  $\not\Rightarrow$  many-time security

For public key encryption:

- One-time security  $\Rightarrow$  many-time security (CPA)  
(follows from the fact that attacker can encrypt by himself)
- Public key encryption **must** be randomized

# Security against active attacks

What if attacker can tamper with ciphertext?

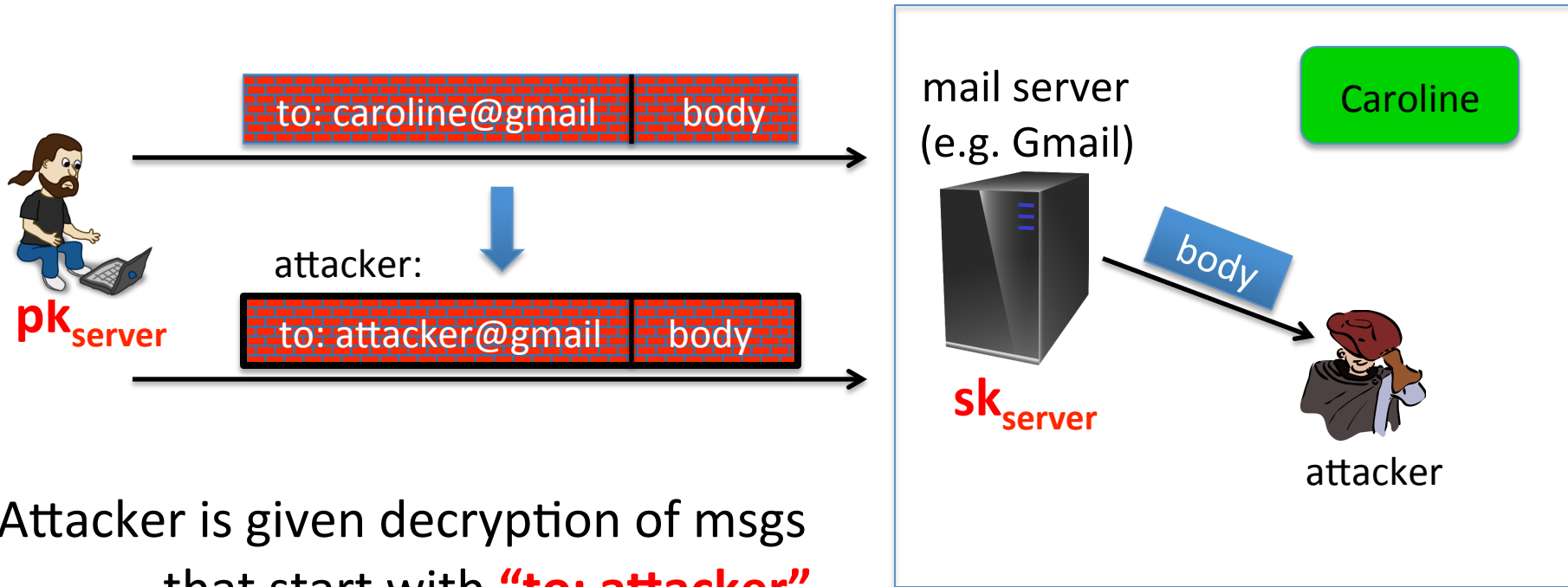

Attacker is given decryption of msgs  
that start with **“to: attacker”**

# (pub-key) Chosen Ciphertext Security: definition

$E = (G, E, D)$  public-key enc. over  $(M, C)$ . For  $b=0,1$  define  $\text{EXP}(b)$ :

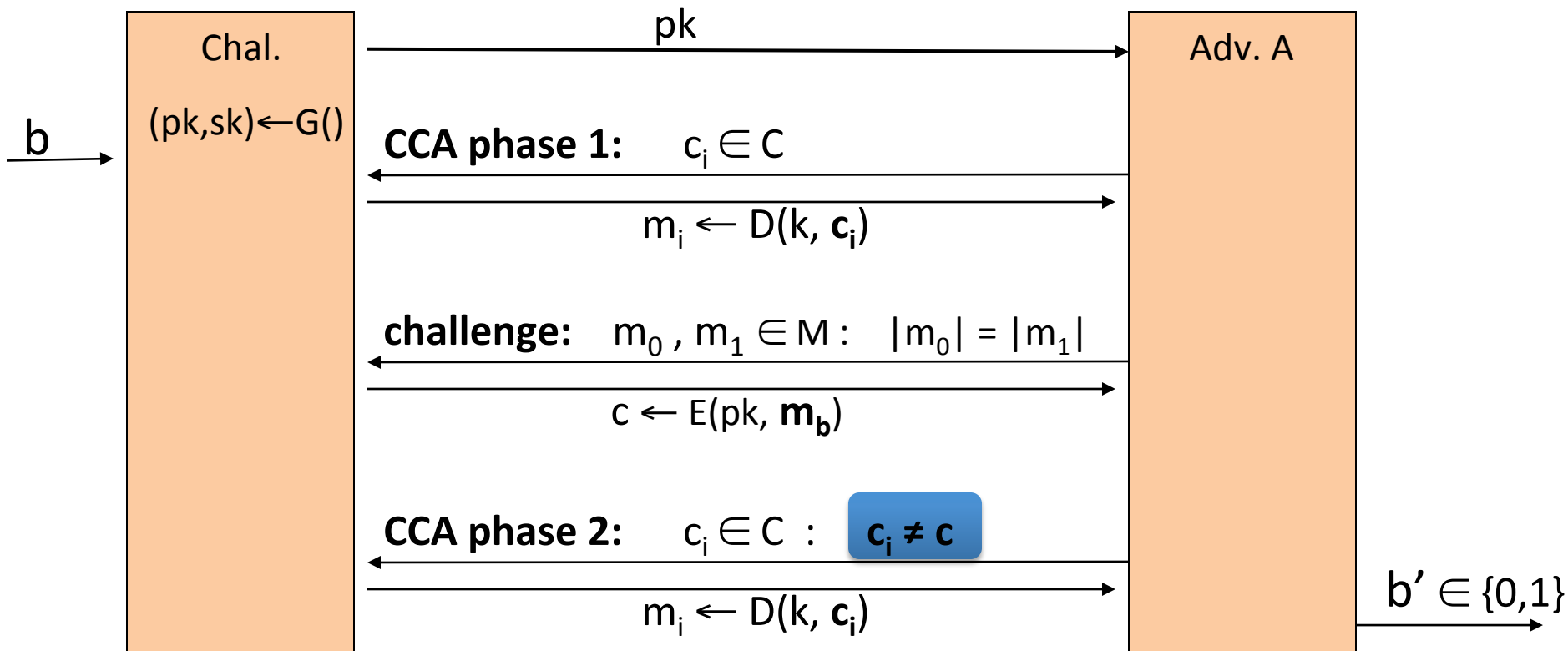



# Chosen ciphertext security: definition

**Def:** E is CCA secure (a.k.a IND-CCA) if for all efficient A:

$$\text{Adv}_{\text{CCA}} [A, E] = \left| \Pr[\text{EXP}(0)=1] - \Pr[\text{EXP}(1)=1] \right| \text{ is negligible.}$$

Example: Suppose

(to: alice, body)

→

(to: david, body)

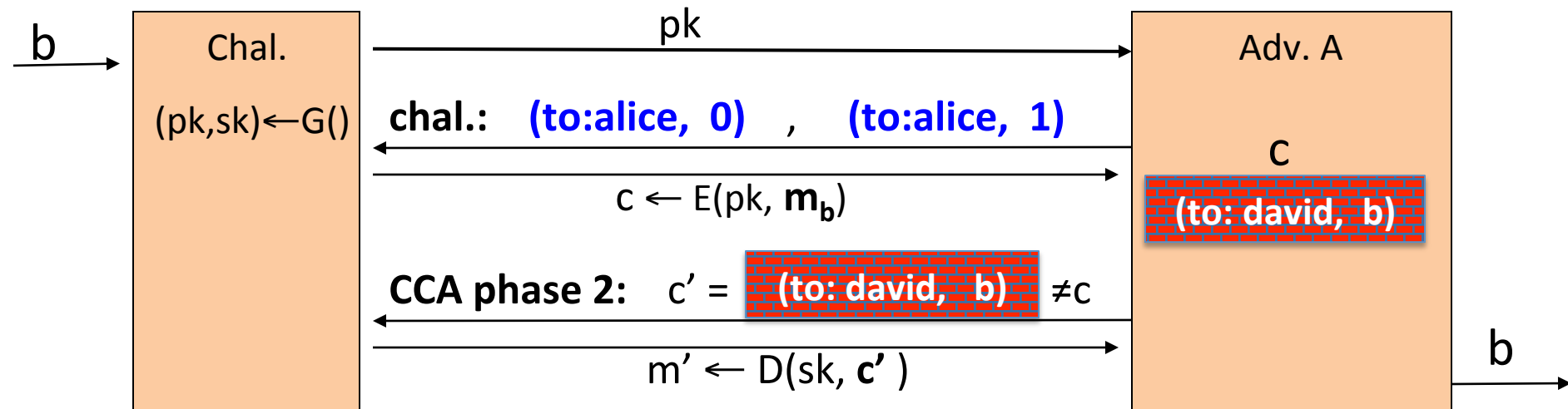

# Active attacks: symmetric vs. pub-key

Recall: secure symmetric cipher provides **authenticated encryption**

[ chosen plaintext security & ciphertext integrity ]

- Roughly speaking: **attacker cannot create new ciphertexts**
- Implies security against chosen ciphertext attacks

In public-key settings:

- Attacker **can** create new ciphertexts using pk !!
- So instead: we directly require chosen ciphertext security

This and next module:

constructing CCA secure pub-key systems

**End of Segment**



# Public Key Encryption from trapdoor permutations

## Constructions

Goal: construct chosen-ciphertext secure public-key encryption

# Trapdoor functions (TDF)

**Def:** a trapdoor func.  $X \rightarrow Y$  is a triple of efficient algs.  $(G, F, F^{-1})$

- $G()$ : randomized alg. outputs a key pair  $(pk, sk)$
- $F(pk, \cdot)$ : det. alg. that defines a function  $X \rightarrow Y$
- $F^{-1}(sk, \cdot)$ : defines a function  $Y \rightarrow X$  that inverts  $F(pk, \cdot)$

More precisely:  $\forall (pk, sk)$  output by  $G$

$$\forall x \in X: F^{-1}(sk, F(pk, x)) = x$$

# Secure Trapdoor Functions (TDFs)

$(G, F, F^{-1})$  is secure if  $F(pk, \cdot)$  is a “one-way” function:

can be evaluated, but cannot be inverted without  $sk$

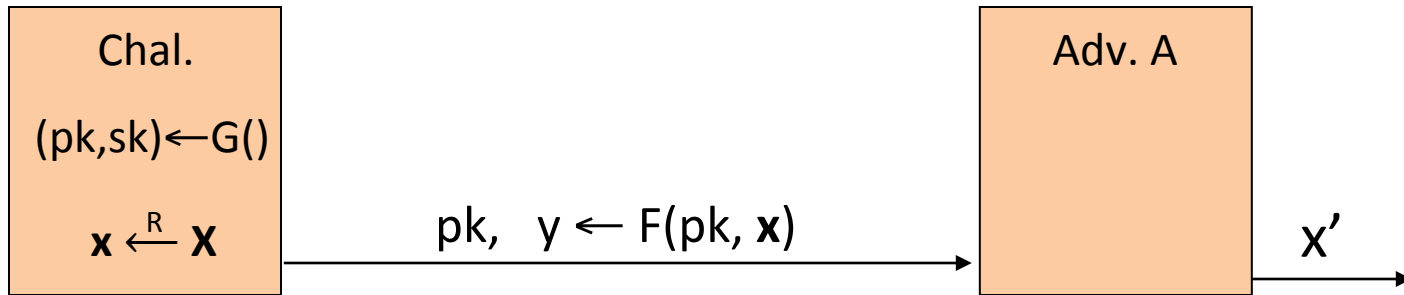

**Def:**  $(G, F, F^{-1})$  is a secure TDF if for all efficient  $A$ :

$$\text{Adv}_{\text{OW}}[A, F] = \Pr[ x = x' ] < \text{negligible}$$

# Public-key encryption from TDFs

- $(G, F, F^{-1})$ : secure TDF  $X \rightarrow Y$
- $(E_s, D_s)$ : symmetric auth. encryption defined over  $(K, M, C)$
- $H: X \rightarrow K$  a hash function

We construct a pub-key enc. system  $(G, E, D)$ :

Key generation  $G$ : same as  $G$  for TDF

# Public-key encryption from TDFs

- $(G, F, F^{-1})$ : secure TDF  $X \rightarrow Y$
- $(E_s, D_s)$ : symmetric auth. encryption defined over  $(K, M, C)$
- $H: X \rightarrow K$  a hash function

$E(pk, m)$  :

$x \xleftarrow{R} X, \quad y \leftarrow F(pk, x)$

$k \leftarrow H(x), \quad c \leftarrow E_s(k, m)$

output  $(y, c)$

$D(sk, (y, c))$  :

$x \leftarrow F^{-1}(sk, y),$

$k \leftarrow H(x), \quad m \leftarrow D_s(k, c)$

output  $m$



In pictures:

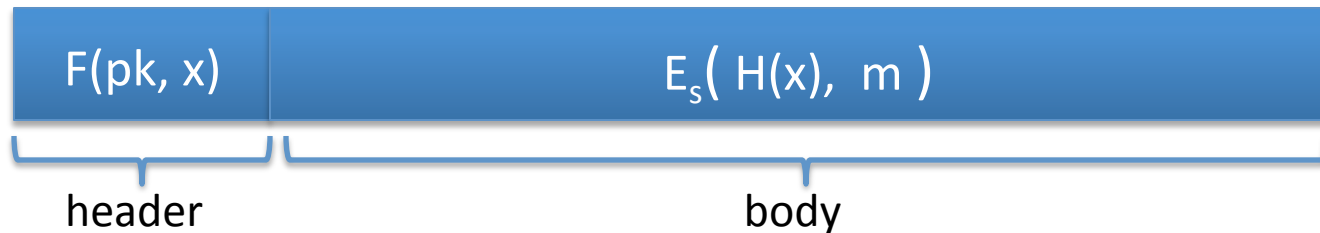

### Security Theorem:

If  $(G, F, F^{-1})$  is a secure TDF,  $(E_s, D_s)$  provides auth. enc.  
and  $H: X \rightarrow K$  is a “random oracle”  
then  $(G, E, D)$  is  $CCA^{ro}$  secure.

# Incorrect use of a Trapdoor Function (TDF)

**Never** encrypt by applying  $F$  directly to plaintext:

$E(pk, m)$  :

output  $c \leftarrow F(pk, m)$

$D(sk, c)$  :

output  $F^{-1}(sk, c)$

Problems:

- Deterministic: cannot be semantically secure !!
- Many attacks exist (next segment)

Next step: construct a TDF

End of Segment



## Public Key Encryption from trapdoor permutations

# The RSA trapdoor permutation

# Review: trapdoor permutations

Three algorithms:  $(G, F, F^{-1})$

- $G$ : outputs  $pk, sk$ .  $pk$  defines a function  $F(pk, \cdot): X \rightarrow X$
- $F(pk, x)$ : evaluates the function at  $x$
- $F^{-1}(sk, y)$ : inverts the function at  $y$  using  $sk$

**Secure** trapdoor permutation:

The function  $F(pk, \cdot)$  is one-way without the trapdoor  $sk$

# Review: arithmetic mod composites

Let  $N = p \cdot q$  where  $p, q$  are prime

$$\mathbb{Z}_N = \{0, 1, 2, \dots, N-1\} \quad ; \quad (\mathbb{Z}_N)^* = \{\text{invertible elements in } \mathbb{Z}_N\}$$

Facts:  $x \in \mathbb{Z}_N$  is invertible  $\iff \gcd(x, N) = 1$

– Number of elements in  $(\mathbb{Z}_N)^*$  is  $\varphi(N) = (p-1)(q-1) = N - p - q + 1$

Euler's thm:

$$\forall x \in (\mathbb{Z}_N)^* : x^{\varphi(N)} = 1$$

# The RSA trapdoor permutation

First published: Scientific American, Aug. 1977.

Very widely used:

- SSL/TLS: certificates and key-exchange
- Secure e-mail and file systems
- ... many others

# The RSA trapdoor permutation

**G()**: choose random primes  $p, q \approx 1024$  bits. Set  $\mathbf{N} = pq$ .

choose integers  $\mathbf{e}, \mathbf{d}$  s.t.  $\mathbf{e} \cdot \mathbf{d} = \mathbf{1} \pmod{\varphi(\mathbf{N})}$

output  $\mathbf{pk} = (\mathbf{N}, \mathbf{e})$  ,  $\mathbf{sk} = (\mathbf{N}, \mathbf{d})$

---

**F(pk, x)**:  $\mathbb{Z}_N^* \rightarrow \mathbb{Z}_N^*$  ;  $\mathbf{RSA}(\mathbf{x}) = \mathbf{x}^{\mathbf{e}}$  (in  $\mathbb{Z}_N$ )

---

**F<sup>-1</sup>(sk, y)** =  $y^{\mathbf{d}}$  ;  $y^{\mathbf{d}} = \mathbf{RSA}(\mathbf{x})^{\mathbf{d}} = x^{\mathbf{ed}} = x^{k\varphi(\mathbf{N})+1} = (x^{\varphi(\mathbf{N})})^k \cdot \mathbf{x} =$   
x



# The RSA assumption

RSA assumption: RSA is one-way permutation

For all efficient algs.  $A$ :

$$\Pr \left[ A(N, e, y) = y^{1/e} \right] < \text{negligible}$$

where  $p, q \xleftarrow{R} n\text{-bit primes}$ ,  $N \leftarrow pq$ ,  $y \xleftarrow{R} \mathbb{Z}_N^*$

# Review: RSA pub-key encryption (ISO std)

$(E_s, D_s)$ : symmetric enc. scheme providing auth. encryption.

$H: Z_N \rightarrow K$  where  $K$  is key space of  $(E_s, D_s)$

- **G()**: generate RSA params:  $pk = (N, e)$ ,  $sk = (N, d)$
- **E(pk, m)**:
  - (1) choose random  $x$  in  $Z_N$
  - (2)  $y \leftarrow \text{RSA}(x) = x^e$ ,  $k \leftarrow H(x)$
  - (3) output  $(y, E_s(k, m))$
- **D(sk, (y, c))**: output  $D_s(H(\text{RSA}^{-1}(y)), c)$

# Textbook RSA is insecure

Textbook RSA encryption:

– public key:  $(N, e)$

Encrypt:  $c \leftarrow m^e$  (in  $Z_N$ )

– secret key:  $(N, d)$

Decrypt:  $c^d \rightarrow m$

Insecure cryptosystem !!

– Is not semantically secure and many attacks exist

$\Rightarrow$  The RSA trapdoor permutation is not an encryption scheme !

# A simple attack on textbook RSA

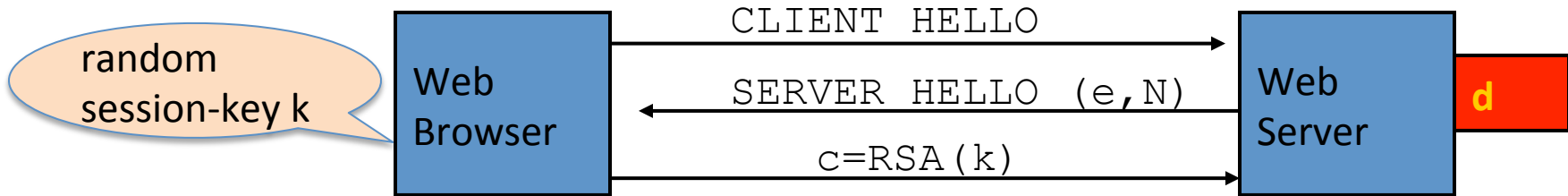

Suppose  $k$  is 64 bits:  $k \in \{0, \dots, 2^{64}\}$ . Eve sees:  $c = k^e$  in  $Z_N$

If  $k = k_1 \cdot k_2$  where  $k_1, k_2 < 2^{34}$  (prob.  $\approx 20\%$ ) then  $c/k_1^e = k_2^e$  in  $Z_N$

Step 1: build table:  $c/1^e, c/2^e, c/3^e, \dots, c/2^{34e}$ . time:  $2^{34}$

Step 2: for  $k_2 = 0, \dots, 2^{34}$  test if  $k_2^e$  is in table. time:  $2^{34}$

Output matching  $(k_1, k_2)$ .

Total attack time:  $\approx 2^{40} \ll 2^{64}$

End of Segment



# Public Key Encryption from trapdoor permutations

## PKCS 1

# RSA encryption in practice

Never use textbook RSA.

RSA in practice (since ISO standard is not often used) :

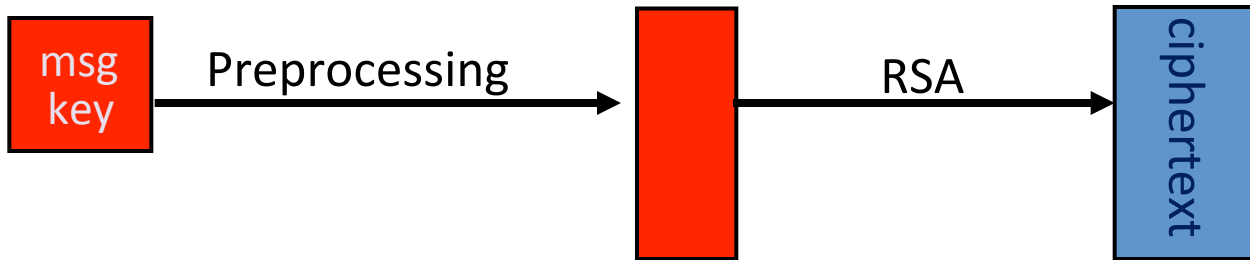

Main questions:

- How should the preprocessing be done?
- Can we argue about security of resulting system?

# PKCS1 v1.5

PKCS1 mode 2: (encryption)

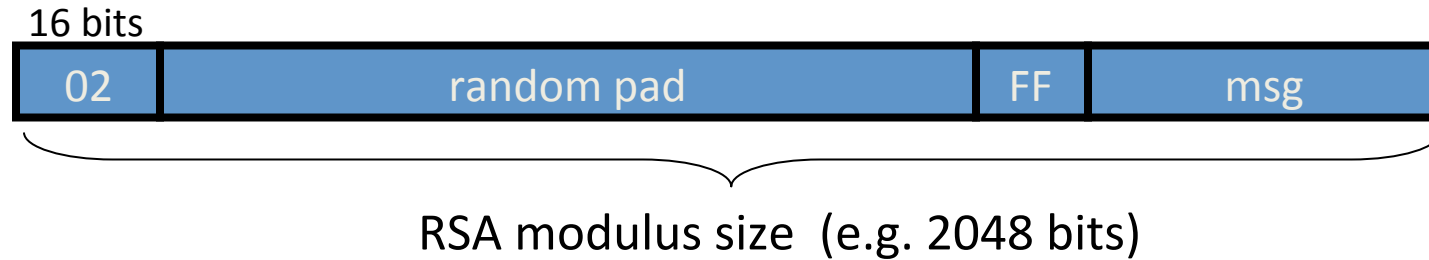

- Resulting value is RSA encrypted
- Widely deployed, e.g. in HTTPS



# Attack on PKCS1 v1.5

(Bleichenbacher 1998)

PKCS1 used in HTTPS:

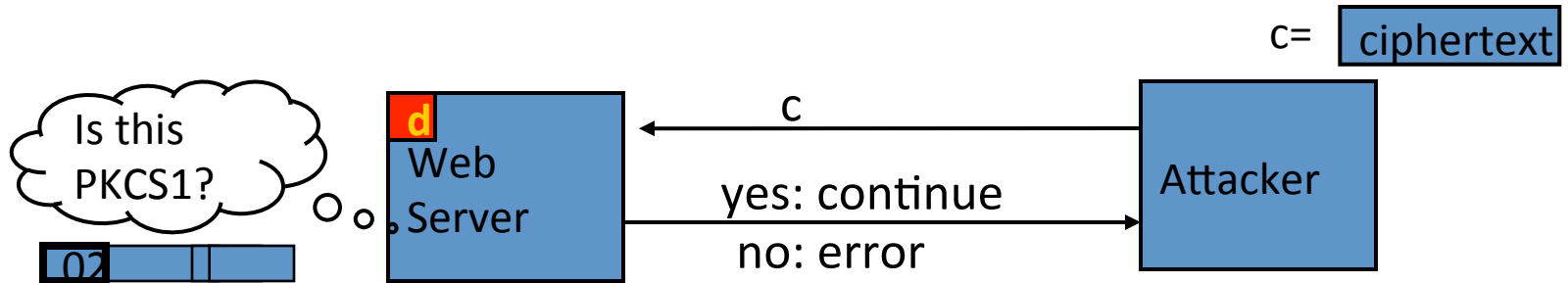

⇒ attacker can test if 16 MSBs of plaintext = '02'

Chosen-ciphertext attack: to decrypt a given ciphertext  $C$  do:

- Choose  $r \in \mathbb{Z}_N$ . Compute  $c' \leftarrow r^e \cdot c = (r \cdot \text{PKCS1}(m))^e$
- Send  $c'$  to web server and use response

# Baby Bleichenbacher

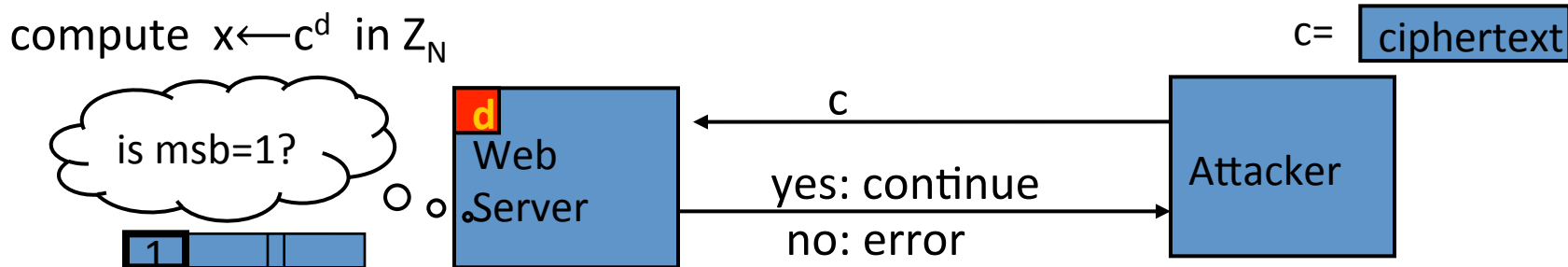

Suppose  $N$  is  $N = 2^n$  (an invalid RSA modulus). Then:

- Sending  $c$  reveals  $\text{msb}(x)$
- Sending  $2^e \cdot c = (2x)^e$  in  $Z_N$  reveals  $\text{msb}(2x \bmod N) = \text{msb}_2(x)$
- Sending  $4^e \cdot c = (4x)^e$  in  $Z_N$  reveals  $\text{msb}(4x \bmod N) = \text{msb}_3(x)$
- ... and so on to reveal all of  $x$

# HTTPS Defense (RFC 5246)

*Attacks discovered by Bleichenbacher and Klima et al. ... can be avoided by treating incorrectly formatted message blocks ... in a manner indistinguishable from correctly formatted RSA blocks.  
In other words:*

- 1. Generate a string **R** of 46 random bytes*
- 2. Decrypt the message to recover the plaintext **M***
- 3. If the PKCS#1 padding is not correct*  
$$\text{pre\_master\_secret} = \mathbf{R}$$

# PKCS1 v2.0: OAEP

New preprocessing function: OAEP [BR94]

check pad  
on decryption.  
reject CT if invalid.

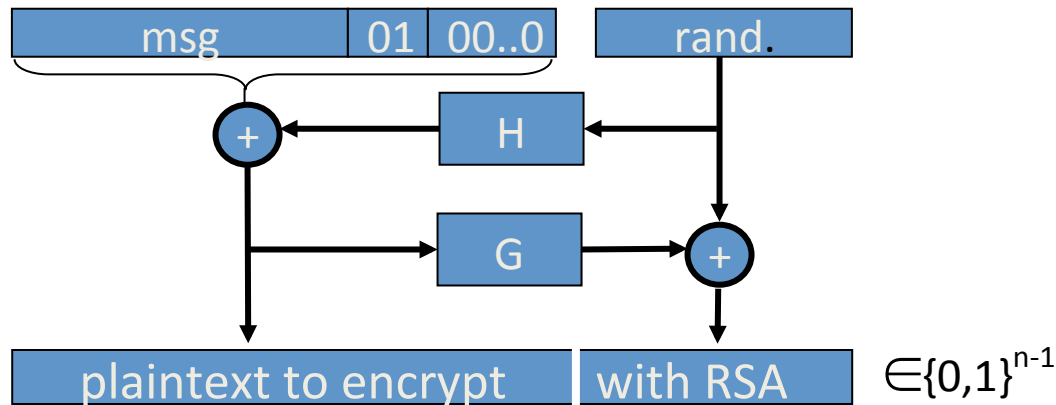

**Thm** [FOPS'01]: RSA is a trap-door permutation  $\Rightarrow$   
RSA-OAEP is CCA secure when  $H, G$  are *random oracles*

in practice: use SHA-256 for  $H$  and  $G$

# OAEP Improvements

**OAEP+**: [Shoup'01]

$\forall$  trap-door permutation  $F$   
 $F$ -OAEP+ is CCA secure when  
 $H, G, W$  are *random oracles*.

During decryption validate  $W(m,r)$  field.

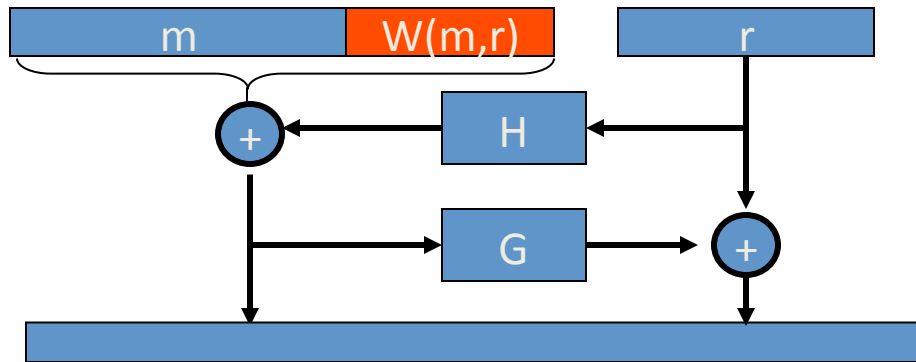

**SAEP+**: [B'01]

RSA ( $e=3$ ) is a trap-door perm  $\Rightarrow$   
RSA-SAEP+ is CCA secure when  
 $H, W$  are *random oracle*.

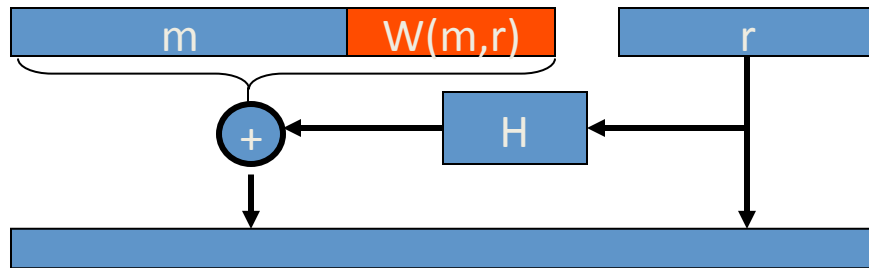

How would you decrypt an SAEP ciphertext **ct** ?

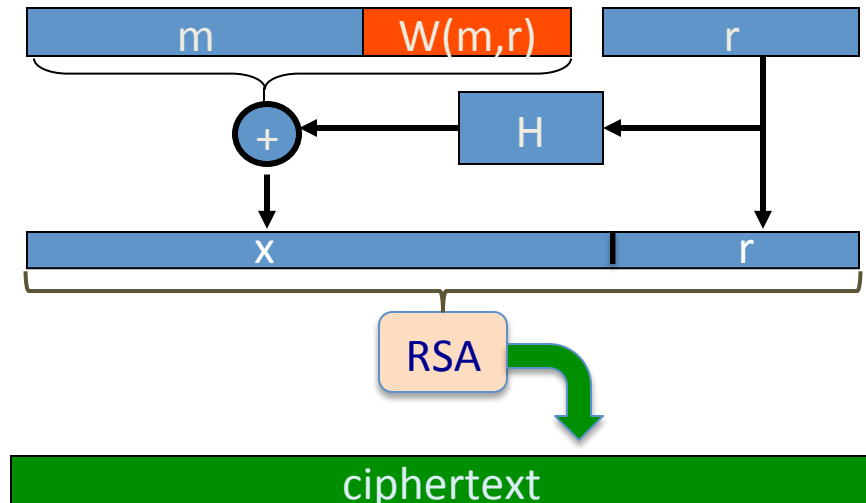

- 
- $(x,r) \leftarrow \text{RSA}^{-1}(\text{sk}, \text{ct})$  ,  $(m,w) \leftarrow x \oplus H(r)$  , output  $m$  if  $w = W(m,r)$
  - $(x,r) \leftarrow \text{RSA}^{-1}(\text{sk}, \text{ct})$  ,  $(m,w) \leftarrow r \oplus H(x)$  , output  $m$  if  $w = W(m,r)$
  - $(x,r) \leftarrow \text{RSA}^{-1}(\text{sk}, \text{ct})$  ,  $(m,w) \leftarrow x \oplus H(r)$  , output  $m$  if  $r = W(m,x)$

# Subtleties in implementing OAEP

[M '00]

```
OAEP-decrypt(ct):  
    error = 0;  
    .....  
    if (  $\text{RSA}^{-1}(\text{ct}) > 2^{n-1}$  )  
        { error = 1; goto exit; }  
    .....  
    if (  $\text{pad}(\text{OAEP}^{-1}(\text{RSA}^{-1}(\text{ct}))) \neq \text{"01000"}$ )  
        { error = 1; goto exit; }
```

Problem: timing information leaks type of error

⇒ Attacker can decrypt any ciphertext

Lesson: Don't implement RSA-OAEP yourself !

End of Segment





## Public Key Encryption from trapdoor permutations

Is RSA a one-way  
function?

# Is RSA a one-way permutation?

To invert the RSA one-way func. (without  $d$ ) attacker must compute:

$$x \text{ from } c = x^e \pmod{N}.$$

How hard is computing  $e$ 'th roots modulo  $N$  ??

Best known algorithm:

- Step 1: factor  $N$  (hard)
- Step 2: compute  $e$ 'th roots modulo  $p$  and  $q$  (easy)

# Shortcuts?

Must one factor  $N$  in order to compute  $e$ 'th roots?

To prove no shortcut exists show a reduction:

- Efficient algorithm for  $e$ 'th roots mod  $N$   
 $\Rightarrow$  efficient algorithm for factoring  $N$ .
- Oldest problem in public key cryptography.

Some evidence no reduction exists: (BV'98)

- “Algebraic” reduction  $\Rightarrow$  factoring is easy.

# How **not** to improve RSA's performance

To speed up RSA decryption use small private key  $d$  ( $d \approx 2^{128}$ )

$$c^d = m \pmod{N}$$

Wiener'87: if  $d < N^{0.25}$  then RSA is insecure.

BD'98: if  $d < N^{0.292}$  then RSA is insecure (open:  $d < N^{0.5}$ )

Insecure: priv. key  $d$  can be found from  $(N, e)$

# Wiener's attack

Recall:  $e \cdot d = 1 \pmod{\varphi(N)} \Rightarrow \exists k \in \mathbb{Z} : e \cdot d = k \cdot \varphi(N) + 1$

$$\left| \frac{e}{\varphi(N)} - \frac{k}{d} \right| = \frac{1}{d \cdot \varphi(N)} \leq \frac{1}{\sqrt{N}}$$

---

$$\varphi(N) = N - p - q + 1 \Rightarrow |N - \varphi(N)| \leq p + q \leq 3\sqrt{N} \leq \sqrt{N}$$

$$d \leq N^{0.25}/3 \Rightarrow \left| \frac{e}{N} - \frac{k}{d} \right| \leq \underbrace{\left| \frac{e}{N} - \frac{e}{\varphi(N)} \right|}_{\leq \frac{3\sqrt{N}}{N} \cdot \frac{e}{\varphi(N)} \leq \frac{3}{\sqrt{N}} \leq \frac{1}{2d^2} - \frac{1}{\sqrt{N}}} + \left| \frac{e}{\varphi(N)} - \frac{k}{d} \right| \leq \frac{1}{2d^2}$$

$\frac{1}{2d^2} - \frac{1}{\sqrt{N}} \geq \frac{3}{\sqrt{N}}$

→ Continued fraction expansion of  $e/N$  gives  $k/d$ .

$e \cdot d = 1 \pmod{k} \Rightarrow \gcd(d, k) = 1 \Rightarrow$  can find  $d$  from  $k/d$

End of Segment



# Public Key Encryption from trapdoor permutations

## RSA in practice

# RSA With Low public exponent

To speed up RSA encryption use a small  $e$ :  $c = m^e \pmod{N}$

- Minimum value:  $e=3$  ( $\gcd(e, \varphi(N)) = 1$ )
- Recommended value:  $e=65537=2^{16}+1$

Encryption: 17 multiplications

Asymmetry of RSA: fast enc. / slow dec.

– ElGamal (next module): approx. same time for both.



# Key lengths

Security of public key system should be comparable to security of symmetric cipher:

<u>Cipher key-size</u>	RSA <u>Modulus size</u>
80 bits	1024 bits
128 bits	3072 bits
256 bits (AES)	<b><u>15360</u></b> bits

# Implementation attacks

**Timing attack:** [Kocher et al. 1997] , [BB'04]

The time it takes to compute  $c^d \pmod{N}$  can expose  $d$

**Power attack:** [Kocher et al. 1999]

The power consumption of a smartcard while it is computing  $c^d \pmod{N}$  can expose  $d$ .

**Faults attack:** [BDL'97]

A computer error during  $c^d \pmod{N}$  can expose  $d$ .

A common defense: check output. 10% slowdown.

# An Example Fault Attack on RSA (CRT)

A common implementation of RSA decryption:  $x = c^d$  in  $Z_N$

decrypt mod  $p$ :  $x_p = c^d$  in  $Z_p$   
decrypt mod  $q$ :  $x_q = c^d$  in  $Z_q$  } combine to get  $x = c^d$  in  $Z_N$

Suppose error occurs when computing  $x_q$ , but no error in  $x_p$

Then: output is  $x'$  where  $x' = c^d$  in  $Z_p$  but  $x' \neq c^d$  in  $Z_q$

$\Rightarrow (x')^e = c$  in  $Z_p$  but  $(x')^e \neq c$  in  $Z_q \Rightarrow \gcd((x')^e - c, N) = p$

# RSA Key Generation Trouble [Heninger et al./Lenstra et al.]

OpenSSL RSA key generation (abstract):

```
prng.seed(seed)
p = prng.generate_random_prime()
prng.add_randomness(bits)
q = prng.generate_random_prime()
N = p*q
```

Suppose poor entropy at startup:

- Same  $p$  will be generated by multiple devices, but different  $q$
- $N_1, N_2$  : RSA keys from different devices  $\Rightarrow \gcd(N_1, N_2) = p$

# RSA Key Generation Trouble [Heninger et al./Lenstra et al.]

Experiment: factors 0.4% of public HTTPS keys !!

Lesson:

- Make sure random number generator is properly seeded when generating keys

# Further reading

- Why chosen ciphertext security matters, V. Shoup, 1998
- Twenty years of attacks on the RSA cryptosystem, D. Boneh, Notices of the AMS, 1999
- OAEP reconsidered, V. Shoup, Crypto 2001
- Key lengths, A. Lenstra, 2004

End of Segment